

Total Pressure Gauge Controller

TPG 300

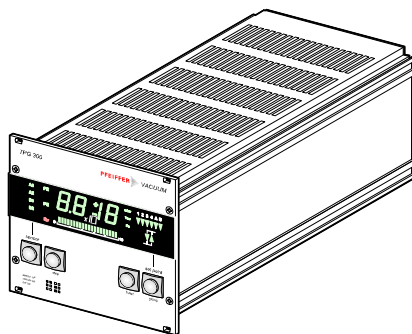

Product Identification

In all communications with Pfeiffer Vacuum, please specify the information on the product nameplate. For convenient reference copy that information into the space provided below.

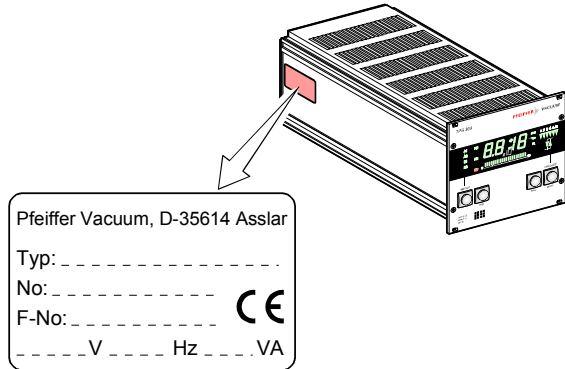

Validity

This document applies to products with part number PT546900-T.

The part number can be taken from the product nameplate.

This document is based on firmware version BG509731-A

If your unit does not work as described in this document, please check that it is equipped with the above firmware version (→ 50).

We reserve the right to make technical changes without prior notice.

All dimensions in mm.

Intended Use

Depending on the options chosen, the TPG 300 can measure total pressure from atmosphere to 10^{-11} mbar. It can trigger a number of pressure-dependent functions to control and monitor vacuum devices and processes. The instructions contained in this document must be strictly followed.

Contents

Product Identification	2
Validity	2
Intended Use	2
1 Safety	5
1.1 Symbols Used	5
1.2 Personnel Qualifications	5
1.3 General Safety Instructions	6
1.4 Liability and Warranty	6
1.5 Further Symbols	7
2 System Overview	8
2.1 Basic Unit	8
2.2 Measurement Plug-In Boards	8
2.3 Interface and Relay Plug-In Boards	9
3 Technical Data	10
4 Installation	13
4.1 Installation	13
4.1.1 Rack Installation	13
4.1.2 Installation in a Control Panel	14
4.1.3 Use as Desk-Top Unit	16
4.2 Mains Power Connection	19
4.3 Installing/Removing plug-in boards	20
4.4 Connecting plug-in boards	21
5 Operation	22
5.1 Front panel	22
5.2 Switching TPG 300 On and Off	23
5.3 Measuring with the TPG 300	24
5.4 Operating Modes	25
5.5 Operating Mode »sensor«	26
5.5.1 Key Entries	27
5.5.2 Switching the Measuring Circuit On/Off	28
5.5.3 Measurement Range Violation	28
5.5.4 Automatic Measuring Circuit Switchover	29
5.5.5 Self-Monitoring	30
5.5.6 Plug-In Board Identification	30
5.6 »set point« Mode	32
5.6.1 Key Entries	34
5.6.2 Parameter	34
5.7 »set up« Mode	35
5.7.1 Key Entries, Overview	36
5.7.2 »Switching Functions« Group	38
5.7.3 »PE Measurement Underrange Control« Group	41
5.7.4 »Measurement Unit« Group	41
5.7.5 »Filter« Group	42
5.7.6 »Interface« Group	44

5.7.7	»Parameter Storage« Group	45
5.7.8	»Test Programs« Group	50
6	Maintenance	54
7	Troubleshooting	55
7.1	Error Messages	55
7.2	Contact Setting of the Relays in the Event of a Fault	56
7.3	Installation Problems	56
7.4	Operating and Calibration Problems	57
8	RS232C Interface	59
8.1	Installation	59
8.2	Data Transmission	59
8.2.1	Definitions	59
8.2.2	Flow Control	60
8.2.3	Communication Protocol	60
8.3	Mnemonics	62
8.3.1	Measurement Values	63
8.3.2	Switching Functions	64
8.3.3	Display	65
8.3.4	Filter Time Constant	66
8.3.5	Baud Rate	66
8.3.6	Storing Parameters	66
8.3.7	Auxiliary Functions	67
8.3.8	Error Messages	68
8.3.9	Example	68
9	Profibus Interface	70
10	Accessories	71
11	Storage	72
12	Disposal	72
	Appendix	73
A:	Conversion Tables	73
B:	Default Parameters	74
C:	Program Examples	75
D:	Literature	76
E:	Index	78
	Declaration of Conformity	80

1 Safety

1.1 Symbols Used



DANGER

Information on preventing any kind of physical injury.



WARNING

Information on preventing extensive equipment and environmental damage.



Caution

Information on correct handling or use. Disregard can lead to malfunctions or minor equipment damage.

1.2 Personnel Qualifications



Skilled personnel

All work described in this document may only be carried out by persons who have suitable technical training and the necessary experience or who have been instructed by the end-user of the product.

1.3 General Safety Instructions

- Adhere to the applicable regulations and take the necessary precautions for all work you are going to do and consider the safety instructions in this document.

STOP
DANGER



Caution: mains voltage

Contact with live parts is extremely hazardous when any objects are introduced or any liquids penetrate into the unit.

Make sure no objects enter through the louvers and no liquids penetrate into the equipment.

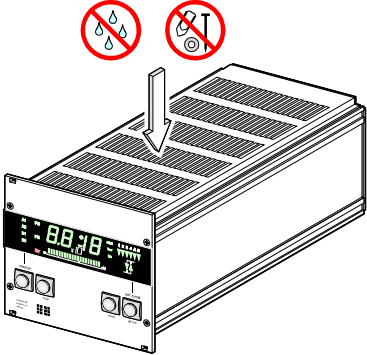

Communicate the safety instructions to all other users.

1.4 Liability and Warranty

Pfeiffer Vacuum assumes no liability and the warranty becomes null and void if the end-user or third parties

- disregard the information in this document
- use the product in a non-conforming manner
- make any kind of interventions (modifications, alterations etc.) on the product
- use the product with accessories, options and add-ons not listed in the corresponding product documentation.

1.5 Further Symbols



... please contact your local Pfeiffer Vacuum service center.



Important Notice



Note
Special information on cost-effective use.



Labeling



Display, response



Operating mode, effect



Waiting time, reaction time, duration of test



See document ...



See page ...

2 System Overview

2.1 Basic Unit

TPG 300, Technical Data → 10.

A list of all plug-in boards suited for the TPG 300 can be found on 11.

For detailed information on the plug-in boards → [1].



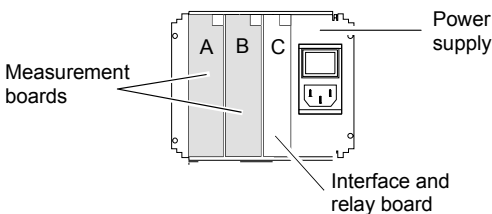

2.2 Measurement Plug-In Boards

Two slots (A and B) at the back of the TPG 300 can accommodate up to two measurement boards.

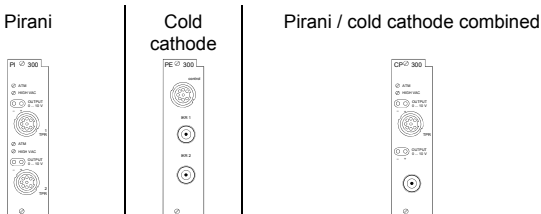

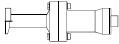
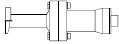
Measurement plug-in boards:





	PI 300D	PI 300DN	PE300DC9	CP300C9	CP300C10	CP300T11
Compatible gauges:						
TPR 010 	•			•	•	•
TPR 017 		•				
TPR 018 	•			•	•	•
IKR 050 			•	•	•	
IKR 060 			•	•	•	
IKR 070 						•

2.3 Interface and Relay Plug-In Boards

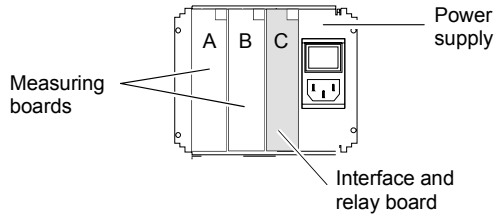

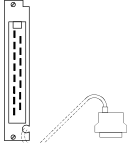
An interface and relay board can be plugged into slot C.



RS232C Interface and Relays IF 300A	RS232C Interface and Relays IF 300B	RS422 Interface and Relays IF 300C	Profibus-DP Interface and Relays IF 300P
			

3 Technical Data

Mains Power Connection	Voltage	90 ... 264 VAC ±10%
	Frequency	47 ... 63 Hz
	Power consumption	<55 VA
	Overvoltage category	II
	Protection class	1
	Connection	European appliance connector IEC 320 C14
	Fuses	none
Ambiance Conditions	Admissible temperature	
	Storage	-40 ... +65 °C
	Operation	
	Rack installation	+ 5 ... +50 °C
	Bench-top unit	+ 5 ... +40 °C
		+ 5 ... +50 °C (with cover/hinged feet)
	Relative humidity	≤80% at temperatures up to +31 °C decreasing to 50% at +40 °C
	Use	Indoors only, height up to 2000 m
Pollution degree	2	
Degree of protection	IP20	
Slots for Plug-In Boards	Measurement boards	2 (slot A and B)
	Interface and relay boards	1 (slot C)

Compatible Measurement Boards	Pirani	PI 300D PI 300DN
	Cold cathode	PE 300DC9
	Pirani / Cold cathode combined	CP 300C9 CP 300C10 CP 300T11
Compatible Interface and Relay Boards	RS232C interface (D-Sub-Connector) and Relays	IF 300A
	RS232C interface (cable) and Relays	IF 300B
	RS422 interface and Relays	IF 300C
	Profibus-DP interface and Relays	IF 300P
Measurement Range		depending on the measurement boards used (→  [1])
Operation Controls	Manually	By 4 push buttons (keys) on the front panel
	Computer controlled	Via RS232C, RS422 or Profibus-DP interface, depending on the interface relay boards used (→  [1])
Measured Values	Measurement range	depending on the measurement boards used (→  [1])
	Measurement rate	100 / s
	Display rate	5 / s
	Filter time constant	
	fast (FI 1)	≈ 16 ms
	normal (FI 2)	≈ 160 ms
slow (FI 3)	≈ 1.6 s	
Measurement unit		mbar, Torr, Pa

Dimensions [mm]

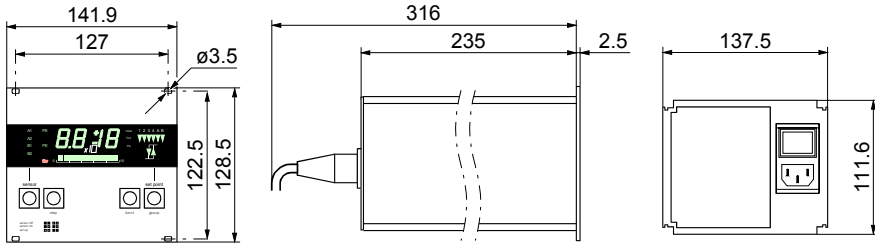

Installation Modes

Rack mounted, panel mounted or bench top.

Weight

1.35 kg (without plug-in boards)

4 Installation



DANGER

Caution: damaged product

Putting a damaged product into operation can be extremely hazardous.

In case of visible damage make sure the product is not put into operation.



Skilled personnel

The unit may only be installed by persons who have suitable technical training and the necessary experience or who have been instructed by the end-user of the product.

4.1 Installation

The TPG 300 can be installed in a 19" rack, a control panel or operated as a desk top unit.

4.1.1 Rack Installation

The TPG 300 is designed for installation in a 19" rack frame, built according to the DIN 41 494 standard (screws and plastic parts are supplied with it).



DANGER

Caution: protection category of the rack

If the product is installed in a rack, it is likely to lower the protection category of the rack (protection against foreign bodies and water) e.g. the EN 60204-1 regulations for switch cabinets.

Take appropriate measures for the rack to meet the specifications of the protection category.

Installation in a Height 3 U Rack Chassis Adapter

Install rack chassis adapter in rack cabinet and slide TPG 300 into the adapter. Secure TPG 300 with the screws supplied with it.

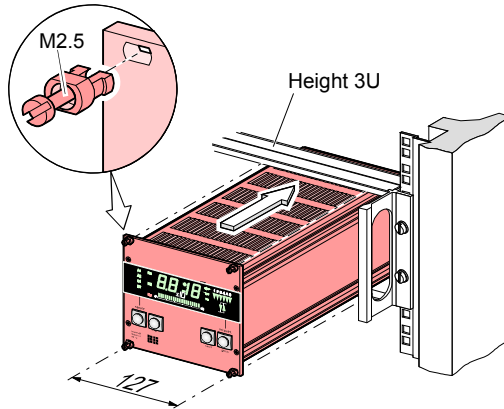

The temperature inside the rack must not exceed the maximum admissible temperature (→ 10).

4.1.2 Installation in a Control Panel

STOP DANGER



Caution: protection category of the control panel

If the product is installed in a rack, it is likely to lower the protection category of the rack (protection against foreign bodies and water) e.g. the EN 60204-1 regulations for switch cabinets.

Take appropriate measures for the control panel to meet the specifications of the protection category.

For mounting the TPG 300 into a control panel, the following cut-out is required:

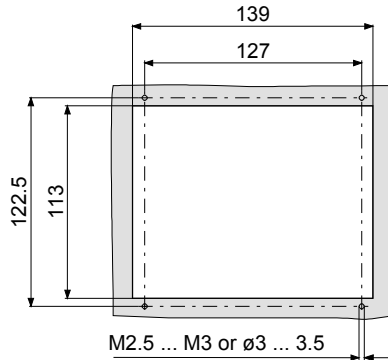

For reducing the mechanical strain on the front panel, preferably support the unit.

Slide the TPG 300 into the cut-out of the control panel and secure it with four M2.5 ... M3 (or equivalent) screws.

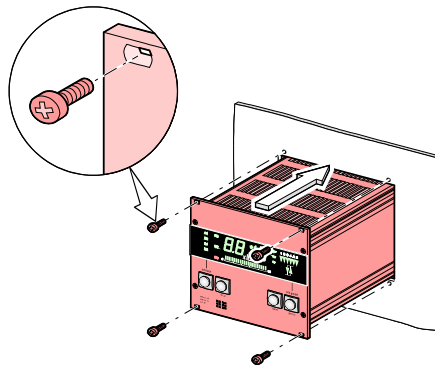

The temperature inside the cabinet must not exceed the maximum admissible temperature (→ 10).

4.1.3 Use as Desk-Top Unit

The TPG 300 is also suited for use as desk-top unit. For this purpose, a conversion kit is available (→  71).

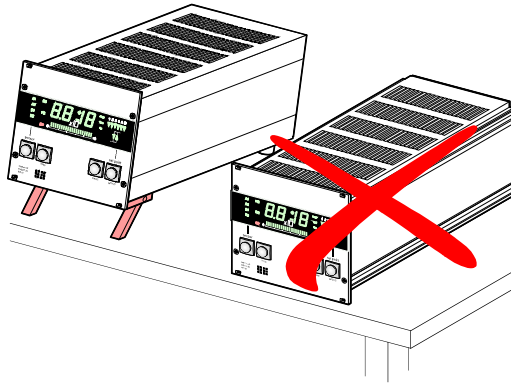

Desk-Top Conversion

- 1** Push the eight press nuts supplied with the kit into the appropriate holes in the side panels.

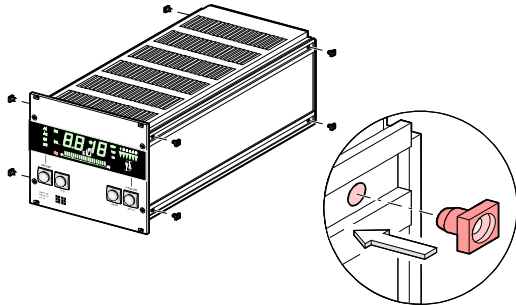

- 2 Fit slotted Cover and secure it with the screws supplied.

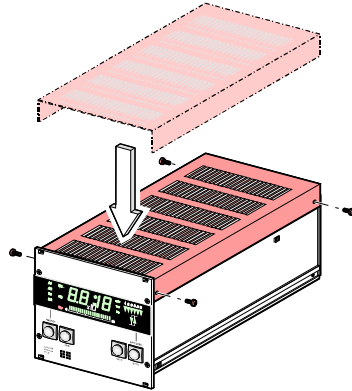

- 3 Mount folding stands and rubber feet onto angle profiles.

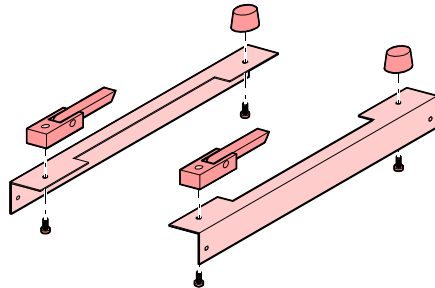

- 4 Turn over the TPG 300 and fix both angle profiles to the TPG 300 side panels as shown.

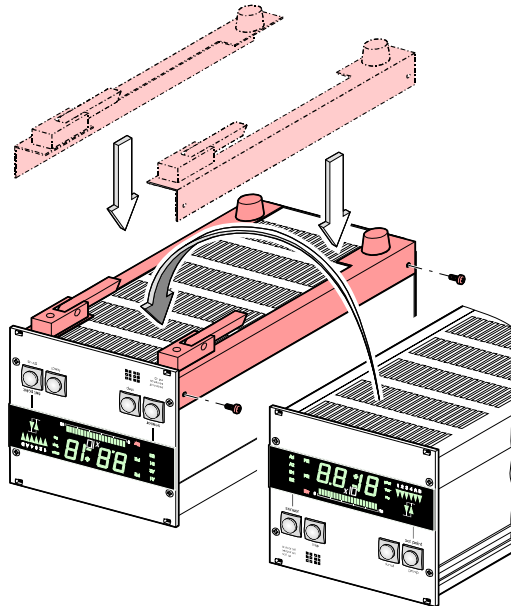

Used as a desk top unit, the temperature inside the cabinet must not exceed the maximum admissible temperature due to the influence of external heat sources (→ 10).

4.2 Mains Power Connection

STOP DANGER



Caution: line voltage

Incorrectly grounded products can be extremely hazardous in the event of a fault.

Use only a 3-conductor power cable with protective ground. The power connector may only be plugged into a socket with a protective ground. The protection must not be nullified by an extension cable without protective ground.

STOP DANGER



No mains line fuse

The TPG 300 has no fuses accessible by the end user.

The line power socket for the TPG 300 has to be fused with max. 10 A.

STOP DANGER



Grounding screw for internal protective ground

The internal protective ground is connected to the TPG 300 power supply rear panel with a grounding screw.

Do not turn or loosen grounding screw.

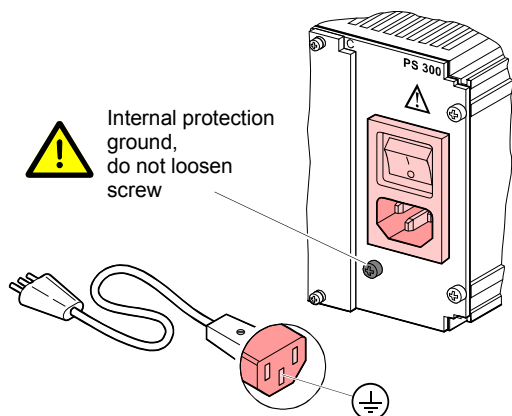

A 2.5 m mains cable is delivered with the TPG 300. If its plug is not compatible with your local power system, replace the cable to suit the local circumstances. Use only a 3-conductor cable with protective ground.

If the TPG 300 is installed in a rack cabinet, the use of a switched mains distributor is strongly recommended.

4.3 Installing/Removing plug-in boards

Factory Configuration

In most cases, the TPG 300 is supplied ready for operation, (with the plug-in boards already installed). In addition, in units for combined measurement of medium and high vacuum, the high vacuum measuring circuit is controlled automatically according to pressure. This is because switching function A and/or B is factory assigned to a medium vacuum measuring circuit (→  29).

There are two types of configuration:

- TPG 300 with CP 300 measurement plug-in board(s)
The cold cathode measuring circuit is controlled by the Pirani measuring circuit which is on the same measurement plug-in board.
- TPG 300 with PI 300D and PE 300 measurement plug-in boards
The cold cathode measuring circuit is controlled by the Pirani measuring circuit <TPR 2> (→  [1], PI 300).

The controlling Pirani gauge and the controlled cold cathode gauge must both be connected to the same vacuum chamber to guarantee efficient operation.

No measuring circuit assignment is activated by all other factory configurations.

Installing/Removing Plug-in Boards

Further information and details on installing/removing plug-in boards and handling of empty slots you find in  [1].

4.4 Connecting plug-in boards

Electrical connections of gauges, analog signals, relays contacts etc. depend on the plug-in boards used and are described in  [1] in detail.

5 Operation

5.1 Front panel

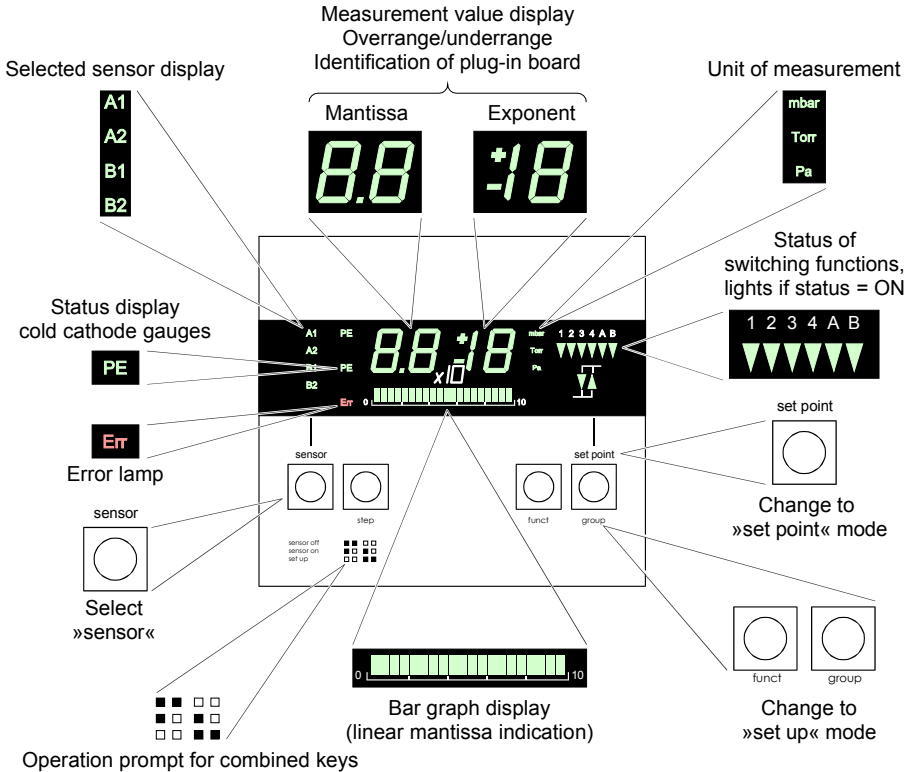

Status Messages

Status messages will be shown on the display instead of the measured value (→ 28, 55).

5.2 Switching TPG 300 On and Off

Before switching the unit on, check that all plug-in boards, connection cables and gauges are installed correctly and that the technical requirements are satisfied.

Switching TPG 300 On

The mains power switch is located on the back panel of the unit.

To switch the TPG 300 on, operate the mains power switch (or the centrally switched mains power distributor in case of installation into a rack).

After the power has been switched on ...

- The unit performs a self-test
- It reactivates the parameters in effect before the unit was switched off
- All measuring circuits with activated hot start (→  45) and all operational Pirani gauges are switched on
- The measurement value of the first measuring circuit in operation is displayed.



Switching TPG 300 Off

To switch the TPG 300 off, operate the mains power switch (or the centrally switched mains power distributor in case of installation into a rack).



Wait at least 10 seconds before switching the TPG 300 on again to allow the unit to initialize itself properly.

5.3 Measuring with the TPG 300

Gas Type Dependence	The measured pressure depends on the gas type present. It is referenced to nitrogen (N ₂). For other gases please refer to the characteristic curves shown in the appendix of  [1].
Validity of Displayed Data	If you intend to use the measurement results for control functions, allow for the time constants of the TPG 300, the gauges, possible ignition delays etc., until valid measurements are displayed (→  [1], [5] ... [7]).
Accuracy of measurement	<p>A generally applicable statement on the accuracy of the measurement cannot be made. The type of gas being measured is a major factor affecting the accuracy, and so is the current condition of the gauge.</p> <p>The accuracy of the gauge at any particular moment can only be assessed by comparing the results with a reference unit. Calibration pumping systems are available for reliable measurements, particularly for pressures under 10⁻⁴ mbar.</p>
Alignment	<p>Cold cathode measuring circuits are factory aligned and require no recalibration.</p> <p>Pirani measuring circuits are factory prealigned. For accurate measurement →  [1].</p>

5.4 Operating Modes

The TPG 300 has three operating modes:

- »sensor«
Pressure measurement (→ 26)
Selection of the measuring circuit (→ 27)
Switching gauges on/off (→ 28)
- »set point«
Display of the switching function parameters (→ 32)
- »set up«
Display of the unit parameters (→ 35)
Modification of the unit parameters (→ 36)
Execution of test programs (→ 50)

Changing the Operating Mode

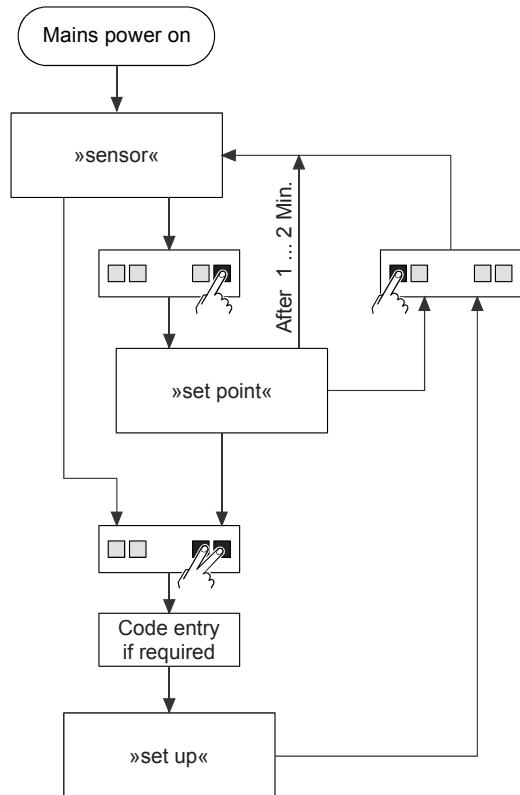

Entering a Code

Changing the operation mode to »set up« and some operations in »sensor« mode require the input of a code, in case it has been assigned previously (→ 46).

By a flashing display («Co d») you will be reminded to input the correct number in the following manner:

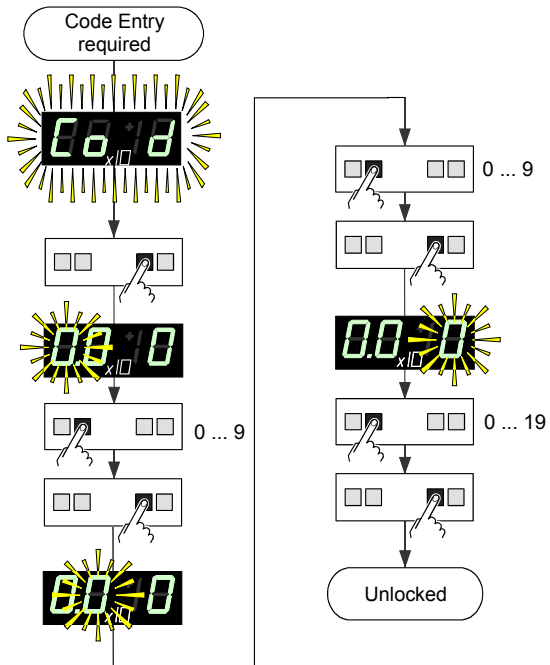

5.5 Operating Mode »sensor«

The »sensor« operating mode is the standard mode of the TPG 300, showing measurement value, status information or a plug-in board identification on the display.

The TPG 300 is in »sensor« mode ...

- After being switched on
- After the <sensor> key has been pushed
- 1 ... 2 minutes after the last keystroke in »set point« mode.

Quitting the »sensor« mode ...

- Switch the mains power switch of the TPG 300 off
- Push the <set point> key (change to <set point> mode)
- Push the <set point> keys simultaneously and enter code, if required (change to »set up« mode).

5.5.1 Key Entries

The following entries are possible in »sensor« mode:

Select
Measuring Circuit

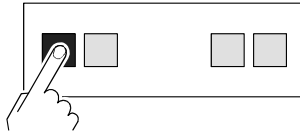

Switch On
Selected Gauge

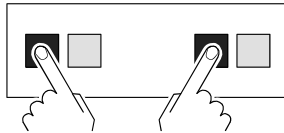

Push simultaneously

Switch Off
Selected Gauge

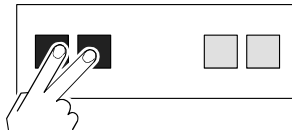

Push simultaneously

Change to »set point«
Mode

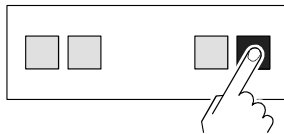

(→ 32)

Change to
»set up« Mode

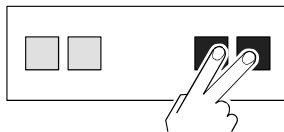

Push simultaneously (→ 35)

5.5.2 Switching the Measuring Circuit On/Off

Each individual measuring circuit can be manually switched on or off with <step> and <funct> (after entering the code → 46). Manual on/off-switching has priority over the automatic control.

Measuring Circuit Switched On

Measured value is displayed:

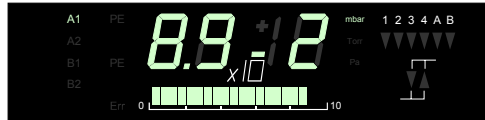

Switch on cold cathode gauges at pressures $<10^{-3}$ mbar only, in order to prevent excessive contamination of the gauges. When the cold cathode measuring circuit is switched on, the lamp «PE» on the front panel lights up.

Measuring Circuit Switched Off

The plug-in board identification is displayed (→ 30):



Pirani gauges are not deactivated by switching them off, only their measuring results and the error message are suppressed. Switching off the cold cathode gauge helps to prevent it from becoming contaminated.

5.5.3 Measurement Range Violation

If the measured value is outside the measuring range of the measuring circuit, this will be indicated if the corresponding measuring circuit is selected. If the cold cathode measuring circuit is controlled by another measuring circuit, the display changes over automatically.

Overrange

Overrange: «or» and exponent indicating the range limit:



If the upper measuring range limit is exceeded, the cold cathode gauge can become contaminated if it remains switched on.

Underrange

Underrange: «ur» and exponent indicating the range limit:



If the under range control is switched off the system cannot distinguish between a gauge failure, cable interruption and underrange of a cold cathode measuring circuit. «ur» is displayed in all cases.

5.5.4 Automatic Measuring Circuit Switchover

If a measuring circuit is controlled by another measuring circuit and either one is selected, the display automatically changes over ...

- When the measured value drops below the lower threshold
- When the measured value exceeds the upper threshold.

Automatic Control

Automatic control: «Au», cold cathode measuring circuit waits for the fulfillment of the power on condition by the Pirani measuring circuit:



5.5.5 Self-Monitoring

If the cold cathode measuring circuit is self-monitored, it automatically switches off

- when the measured value exceeds the upper threshold.

The measuring circuit must be restarted manually. Re-starting can be prevented by another measuring circuit (e.g. Pirani).

Measured value or plug-in board identification:



5.5.6 Plug-In Board Identification

When the measuring circuit is switched off, its identification is displayed (→ 28):



Cold cathode measuring circuit
 5×10^{-9} mbar, automatic operation



Cold cathode measuring circuit
 1×10^{-10} mbar, automatic operation



Cold cathode measuring circuit
 10^{-11} mbar, automatic operation

A digital display with a black background and green characters. It shows 'PE' followed by a small '+' sign and the number '9'.

Cold cathode measuring circuit
 5×10^{-9} mbar

A digital display with a black background and green characters. It shows 'PE' followed by a small '+' sign and the number '10'.

Cold cathode measuring circuit
 1×10^{-10} mbar

A digital display with a black background and green characters. It shows 'PE' followed by a small '+' sign and the number '11'.

Cold cathode measuring circuit
 10^{-11} mbar

A digital display with a black background and green characters. It shows 'PB' followed by a small '+' sign and the number '18'.

Pirani measuring circuit

A digital display with a black background and green characters. It shows 'PB' followed by a small '+' sign and the number '1A'.

Pirani measuring circuit for nickel
filament

5.6 »set point« Mode

With <set point> you can cyclically read, enter and modify the threshold values and assignments of the switching functions.

The Switching Functions

The TPG 300 has six switching functions (1, 2, 3, 4, A, B) with two adjustable thresholds each. The status of each switching function is displayed on the frontpanel. Four of the switching functions provide floating relay contacts accessible on the interface and relay board (→ [1]).

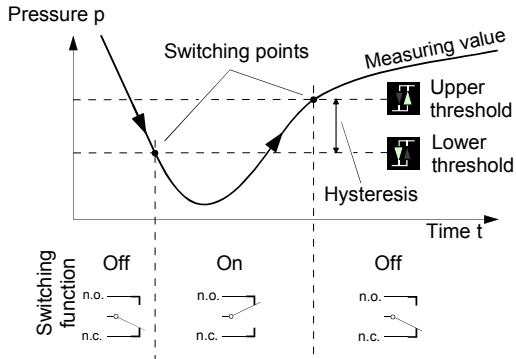

Upper/Lower Threshold

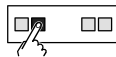

Display

Description/value



Lower threshold, defines pressure value at which the switching function turns on when pressure is dropping.



Upper threshold, defines pressure value at which the switching function turns off when pressure is rising.



Hysteresis (difference between lower and upper threshold) is a minimum of 10% of the lower threshold. This prevents unstable states. If you set the upper threshold too low, the minimum hysteresis will go into effect automatically.

Selecting the »set point« mode:

- Push the <set point> key (only possible in »sensor« mode), the bar graph display extinguishes.

Quitting the »set point« mode:

- Switch off the TPG 300
- Push <sensor> key (change to »sensor« mode)
- Push »set up« keys simultaneously and enter code if necessary (change to »set up« mode)
- Wait 1 ... 2 minutes after the last key was pushed. The TPG 300 then switches automatically back to »sensor« mode (measuring mode).

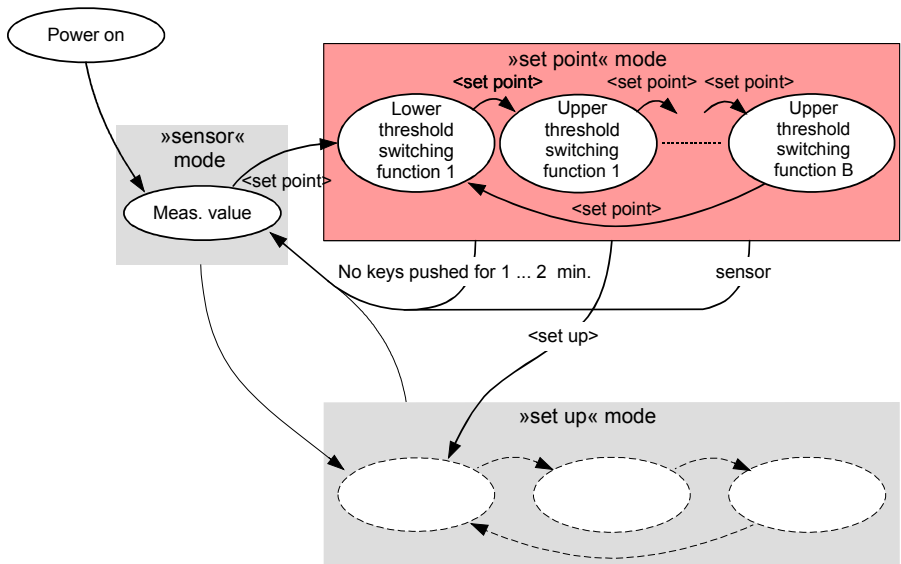

5.6.1 Key Entries

The following entries are possible in the »set point« mode:

Display Threshold Values of Switching Functions

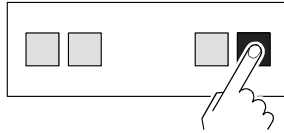

Advance to next threshold

Change to »sensor« Mode

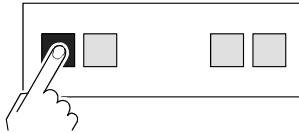

(→ 26)

Change to »set up« Mode

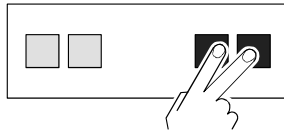

Push simultaneously (→ 35)

(Enter code if required → 26)

5.6.2 Parameter

With <set point> you can read cyclically the threshold values and assignments of the switching functions.

Assignment of switching function

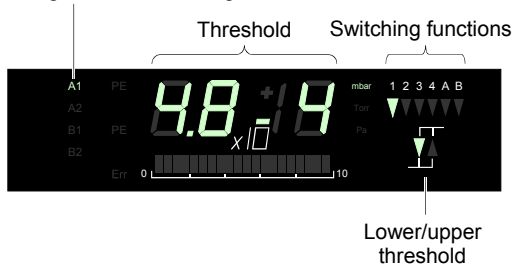



The function of the measuring circuits is not influenced.

The current status of the switching functions is not displayed, but they work nevertheless.

With <set up> you can go directly to the »select threshold« function of the »set up« mode to change the displayed threshold value.

5.7 »set up« Mode

In »set up« mode you can read, enter and modify parameters and run the test programs available on the TPG 300.

Selecting the »set up« mode

- Simultaneously push the <funct> and <group> keys. Enter the code with <step> and <funct> if required (→ 26).

Quitting the »set up« mode

- Switch the mains power switch of the TPG 300 off
- Push the <sensor> key (change to »sensor« mode).

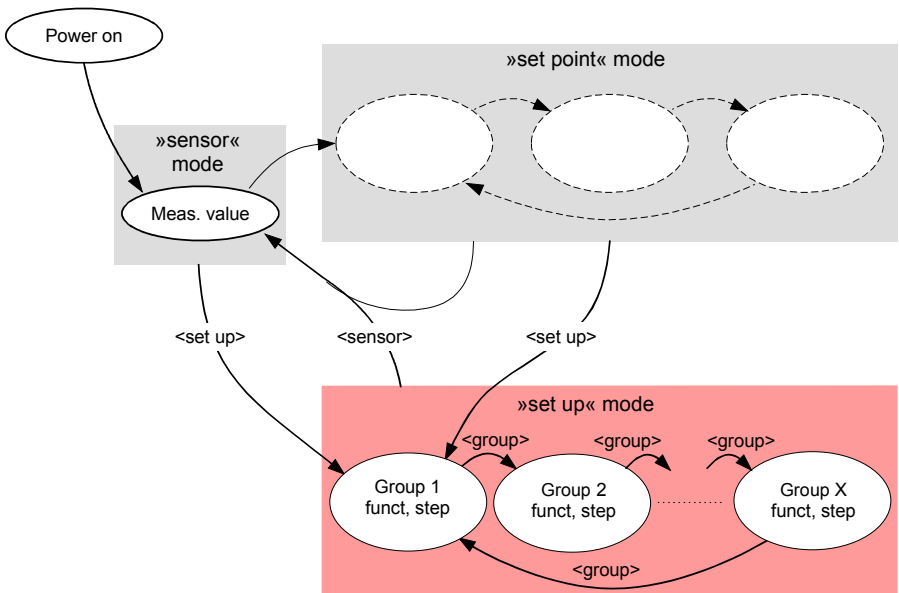

5.7.1 Key Entries, Overview

»set up« mode is organized in three levels. An overview of the structure is shown in the table below.

Inputs in groups, functions and parameters always work cyclically. In case of error, simply go ahead up to the right spot again.

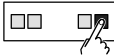
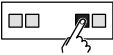
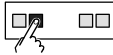
Group <group> 	Function <funct> 	Parameter values <step> 
Switching functions	Switching function selection	1, 2, 3, 4, A, B
	Threshold selection	lower, upper
	Threshold 1st digit	1 ... 9
	Threshold 2nd digit	0 ... 9
	Threshold exponent	-11 ... +3
	Measuring circuit assignment	A1, A2, B1, B2
PE measuring circuit underrange control		0 (disabled) 1 (enabled)
Measurement unit		mbar, Torr, Pa
Filter	Filter assignment	A1, A2, B1, B2
	Filter time constant	1, 2, 3
Interface	Baud rate	300 ... 9600 Baud
Parameter storage	Parameter set selection	u (user) H (Hot start) d (default)
	Storage	Store command
Test programs	Test program selection	dl (display) rA (RAM) EP (EPROM) EE (EEPROM) Ad (A/D converter channels 0 ... 7) lo (keys) rS (interface) Pn (firmware number) Start test

Comments to the table above:

- Groups, functions or parameters which do not exist because of the unit configuration will be bypassed.

The following key entries are possible in »set up« mode:

Select Group

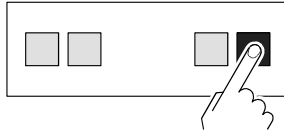

The group is characterized by a flashing display of the first parameter value.

- Switching functions (→ 38)
- PE Measurement Underrange Control (→ 41)
- Measurement unit (→ 41)
- Filter (→ 42)
- Interface (→ 44)
- Parameter storage (→ 45)
- Test programs (→ 50)

Select Function

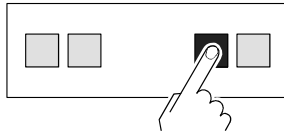

(If existing in this group)

Modify Selected Parameter

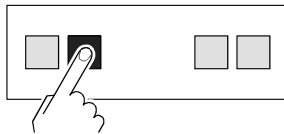

Change to »sensor« Mode

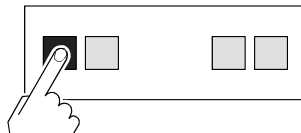

(→ 26)

5.7.2 »Switching Functions« Group

»Switching Function Selection« Function

Switching functions 1 ... 4 affect the relays of an interface and relay plug-in board (→  [1]). A and B can control the on/off switching of the cold cathode gauges.

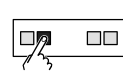

Switching function

Parameter value acts upon:

- | | |
|---|---|
| 1 | Interface and relay plug-in board Relay 1 |
| 2 | Interface and relay plug-in board Relay 2 |
| 3 | Interface and relay plug-in board Relay 3 |
| 4 | Interface and relay plug-in board Relay 4 |
| A | Cold cathode measuring circuit(s) in slot A |
| B | Cold cathode measuring circuit(s) in slot B |

»Threshold Selection« Function

Defining an upper and a lower threshold defines a hysteresis for each switching function.



When the pressure is dropping, the status changes to »on« at the lower threshold and to »off« at the upper threshold (with rising pressure →  32).

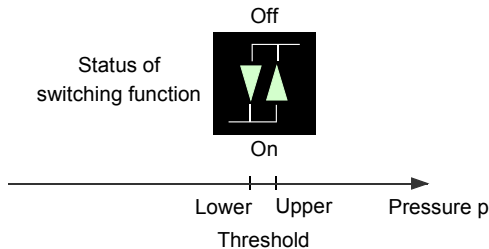



Hysteresis (difference between lower and upper threshold) is a minimum of 10% of the lower threshold. This prevents unstable states. If you set the upper threshold too low, the minimum hysteresis will go into effect automatically.



Threshold selection



Lower Threshold



Upper Threshold

»Threshold Setting« Function



Digit



Value



1 ... 9 (1st digit mantissa)



0 ... 9 (2nd digit mantissa)



-11 ... +3 (exponent)



Modifications only become effective when the switching function, group or operating mode is changed.

»Measuring Circuit Assignment« Function

Any of the switching points can be assigned to any of the measuring channels.



Changing the assignment can trigger a change in the switching function status.

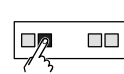

Display	Measuring circuit Assignment ¹⁾
A1	Measuring circuit A1
A2	Measuring circuit A2
B1	Measuring circuit B1
B2	Measuring circuit B2

¹⁾ The cycle depends on the plug-in boards installed.



Available measuring circuits are indicated by an lamp.

The upper and lower thresholds of switching functions 1 ... 4 cannot be assigned to different measuring circuits. The last entry made applies.

The upper and lower thresholds of switching functions A and B can be assigned to different measuring circuits (→ 30).

The lamp for the assigned measuring circuit flashes.

It is possible to leave a switching function unassigned (no measuring circuit lamp will flash). The switching function is ineffective.

Modifications only become effective when the switching function, group or operating mode is changed.

5.7.3 »PE Measurement Underrange Control« Group

The behavior of switching functions assigned to the cold cathode measuring circuit (PE) can be adjusted when underrange occurs (→ 28) (except in the case of self assignment).

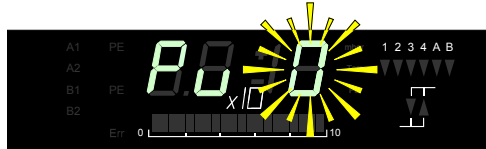

	Description
	»UnderRng« is interpreted as valid measured value; the switching function remains »on«.
	»UnderRng« is interpreted as an error; the switching function changes to »off«. The switching function does not change to »on« until the measured value has remained within the measurement range of the cold cathode measuring circuit for at least 10 seconds.



Cold cathode measuring circuits for 10^{-11} mbar sometimes require more than 10 seconds for the transition «OverRng» ⇒ «UnderRng» and thus lead the switching function being »on« for a short time.

5.7.4 »Measurement Unit« Group

Select the desired measurement unit:





The modification is made immediately.
The threshold values for the switching functions are adapted automatically.

Display	Valid measurement unit
mbar	mbar
Torr	Torr
Pa	Pa

(Conversion table → [73]).

5.7.5 »Filter« Group

In the event of fast varying measurement signals, the measured values can be filtered to stabilize both, the display and the switching functions.



Analog signal output is not affected by the filter (→ [1]).

»Filter Assignment« Function

You can set the filter separately for each individual measuring circuit.



Display ¹⁾	Filter assignment ¹⁾
A1	A1
A2	A2
B1	B1
B2	B2

¹⁾ The cycle depends on the plug-in boards installed.

»Filter
Time Constant«
Function

Three filter time constants are available.



In the case of signal fluctuations, a faster filter can cause 'fluttering' of switching functions.

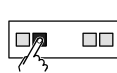
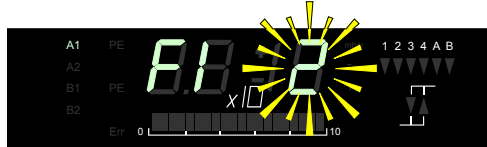

Display	Filter time constant
1	Fast (16 ms)
2	Medium (160 ms)
3	Slow (1.6 s)



Any modification becomes effective immediately.

FI 1 ⇒ fast:

The TPG 300 reacts immediately on variations in measurement value. Therefore it is sensitive to unwanted transients.

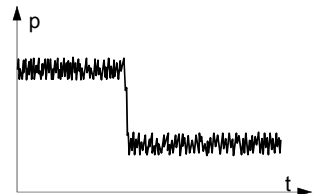

FI 2 ⇒ normal:

Moderate setting. Represents a good compromise between response time and transient immunity for steady readings and reliable operation of switching functions.

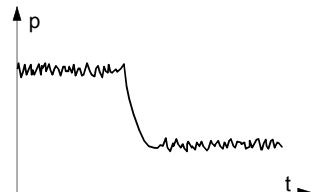

FI 3 ⇨ slow:

The TPG 300 does not react on small changes of measuring value, has a slow response time but suppresses transients effectively.

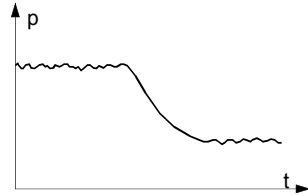

5.7.6 »Interface« Group

»Baud Rate«
Function

Data transfer rate of the RS232C Interface.

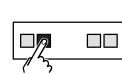
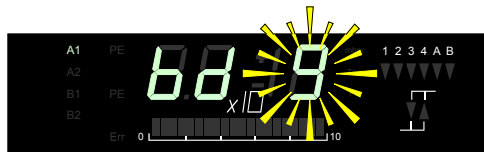

Display	Baud rate
bd 3	300
bd 1	1200
bd 2	2400
bd 4	4800
bd 9	9600



The Baud rates for the TPG 300 and any interfaced computer must be the same.

Using a Profibus-DP interface and relay board IF 300P with the TPG 300, the Baud rate must always be set to 9600 Baud (→ [8]).

5.7.7 »Parameter Storage« Group

»Parameter Set« Function

The stored parameters are activated when the TPG 300 is switched on. If no parameters have been stored, the unit defaults to the standard parameter set (→  74).

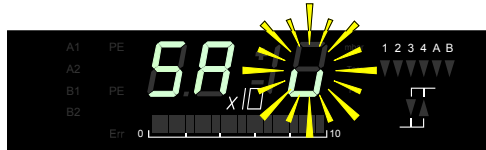

You can either select your own set of parameters (user) or the default set to be saved.

Display	Description
SA u	SA ve user parameters
SA H	Save user parameters with immediate start up (SA ve H ot start)
SA d	Save default (factory set) parameters (SA ve d efaults)



By activating the immediate start-up (hot start), a measuring circuit can be automatically re-enabled after a power failure. This is particularly useful in the case of self-monitoring.

The immediate start-up is jointly activated for all measuring circuits. The measuring circuit must however be switched on during storage.

Code Lock

If «SA u» or «SA H» is selected (store user parameters), you will be asked to enter a code before storage takes place. This is a protection against inadvertent or unauthorized manipulations on the operating states of the sensors or the parameters. In this mode the unit may be unlocked in the same way.

Code	Effect
00 0	No code required for operation
99 19	Operation only possible with this particular code (can not be modified)
xx yy ¹⁾	Operation only possible after entering matching code

¹⁾ Any number is permissible, except "00 0" and "99 19"
(xx = mantissa, yy = exponent on the display).

An existing code lock can be reset or modified (→  48).

Storing the Parameters

Since the input sequence for »Parameter storage« group deviates slightly from the rest, it is recommended to follow the flow diagram below.

- 1 Select type of parameter storage following the diagram:

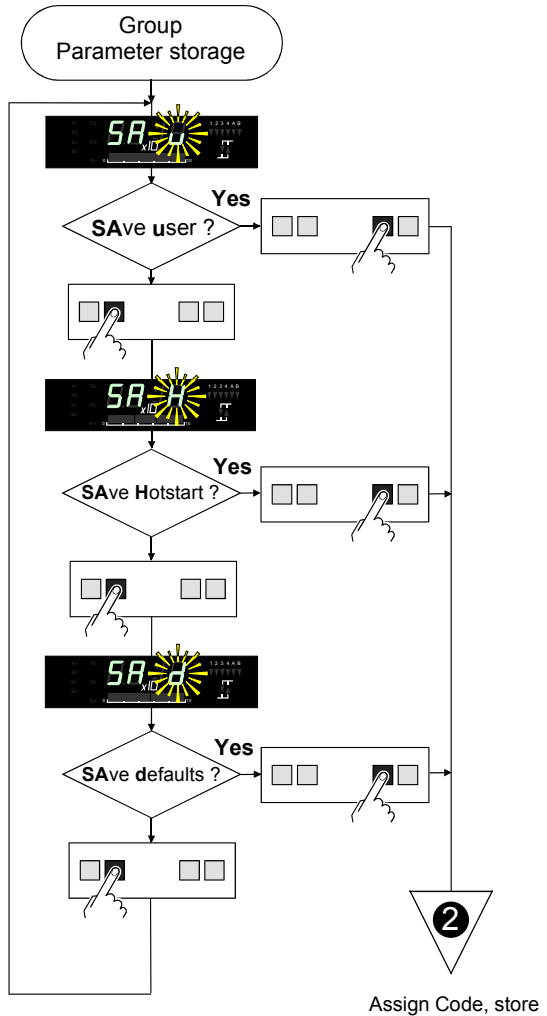

- 2 Store the settings made under 1 by following the instructions in the diagram below. If desired, assign a code to this parameter set. If a modification of an already stored code is not desired, skip these steps by pushing <func> three times.



Saving the default parameters has the following effects:

- The switching function assignments are lost
- The relays are de-energized, i.e. the switching functions change to »off«
- Communication with a computer may no longer be possible.

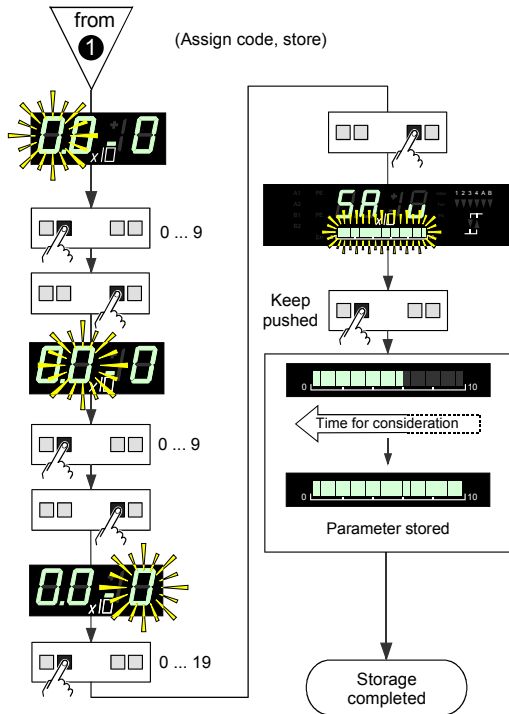



Keep <step> pushed until the bar graph is completely dark. This will lead to properly stored parameters. When the storage process is finished, the bar graph lights again.

Releasing <step> during consideration time will abort the storage process.

Pushing <funct> will bring you back to the start of »Parameter storage«, where the process can be repeated if desired.

3

Take a note of the valid code number (if assigned) and keep it save.



The storage procedure is now completed. The TPG 300 now operates using the new set of parameters.

5.7.8 »Test Programs« Group

Tests marked with * are carried out automatically when the TPG 300 is switched on. You can also run all tests during operation. They do not influence measurements and switching functions.

On selecting the group »test programs«, the display will show "dl", the first item on the list of elements to be tested.

»Test Program Selection« Function

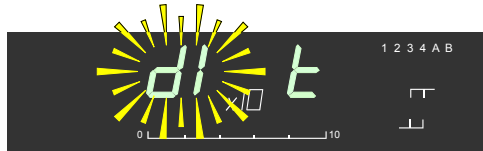

The following tests can be carried out:

Display	Element tested
dl *	Display
rA *	RAM
EP *	EPROM
EE *	EEPROM
Ad	A/D converter
A0	Channel 0
A1	Channel 1
A2	Channel 2
A3	Channel 3
A4	Channel 4
A5	Channel 5
A6	Channel 6
A7	Channel 7
lo *	Keys
rS	RS232C interface
Pn	Program number (Firmware version)

Display Test

The display test lights first all lamps together and then individually.



RAM Test

The RAM routine tests the two kByte of the RAM.

EPROM and EEPROM Test

A check sum is formed and controlled in both, the EPROM and EEPROM test.

- A/D Converter Test** You must enter the channel (0 ... 7) when running the A/D converter test.
(A/D input voltage = display × 5 mV)
- Key Test** «lo» checks whether any key contact is stuck
- Interface Test** «rS» echoes HOST characters coming from the host. It displays them in the Hex format in the mantissa field and their number in the exponent field.
- Program Version** «Pn» shows the installed firmware version. You can read out the program version of your unit by conducting the corresponding test (Pn).

Display	Test sequence
 	<p>The test is carried out automatically:</p> <p>⇒ Both parts of the firmware version number are displayed in succession.</p>
	<p>Modification index (A ... Z, -)</p>

A program number with a higher modification index will eventually provide additional services.

This operating manual is not valid for a more recent program number.

Selection and Execution of Test Programs

Since the input sequence for the group »Test programs« deviates slightly from the rest, it is recommended to follow the flow diagram below.

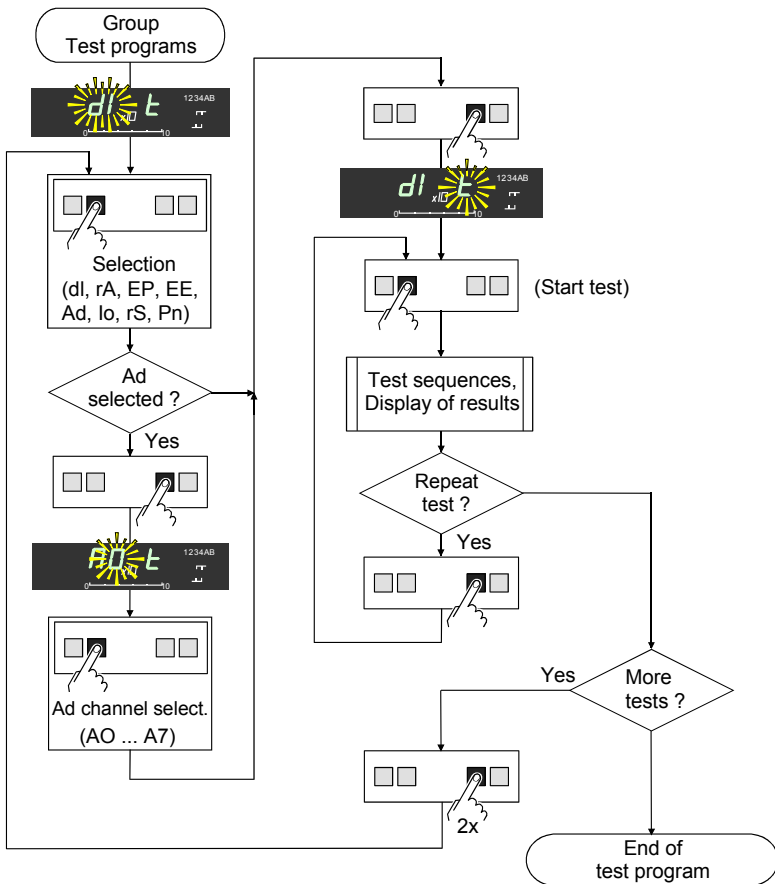





You can always return to »test« by pushing the <funct> key once or twice (depending on status).

The programs «dl», «Ad», «rS», and «Pn» run continually and must be stopped by pushing <funct> or <group>. All the other tests run through once. When they are finished, a line appears in the exponent display field or the checksum is shown.

You can stop the «dl» by pushing <step> and start it again as often as you like.

Detected errors will be reported (→  55).

6 Maintenance

The TPG 300 requires no maintenance. For maintenance of the gauges refer to the respective documents (→  [2], [3], [4], [5], [6], [7]).

Cleaning the TPG 300

Turn the unit off and remove all cables (the mains cable last) before doing any of the work described below.

For cleaning the outside of the unit, a slightly humid cloth will usually do. Do not use under any circumstances an aggressive or scouring cleaning agent.











No water must get into the unit. Before putting the unit into operation again, allow it to dry thoroughly.



7 Troubleshooting

7.1 Error Messages

An error message is indicated by a lit or a flashing «Err» lamp (Example shown: TPR gauge not connected):



Display	Possible cause	Correction
«dt» ²⁾	Watch Dog timer – overflow due to strong external influence (electromagnetic)	 If this error occurs frequently, replace the basic unit
«EE» ²⁾	Error during parameter reading	Store default or user parameters (→  45)
	EEPROM defective	 Service center
«EP» ²⁾	EPROM defective	 Service center
«ld» ²⁾	Operating system overloaded	
«lF» ²⁾	Interface and relay plug-in board in slot A or B	Put the interface and relay plug-in board into slot C ¹⁾
«lo» ²⁾	Key pushed	Release Key
	Key stuck	 Service center
«rA» ²⁾	RAM defective	 Service center
«rS» ²⁾	Data transmission or programming error	Correct/check interface parameter or cable, program
	Interface defective	Replace interface and relay plug-in board ¹⁾
«SE» ³⁾	TPR gauge not connected	Connect gauge
	TPR cable open circuit	Replace cable
	TPR gauge defective	Replace gauge
«So» ²⁾	Stack overflow	

¹⁾ read the information on  20 and in  [1] before performing any manipulations on the plug-in boards

²⁾ Fatal error

³⁾ Fault in measuring circuit (lamp of the corresponding measuring circuit flashes)

7.2 Contact Setting of the Relays in the Event of a Fault

The relays on the IF 300A, IF 300B, IF 300C and IF 300P plug-in boards behave as follows when a fault occurs:

A contact 1 ... 4 (switching functions) is de-energized in the event of:

- A fault in a measuring circuit
- A fatal error.

Contact 5 (error status) is de-energized in the event of:

- A fault in a measuring circuit
- A fatal error.

Additional information on relay contact states →  [1].

7.3 Installation Problems



Problem	Possible cause	Correction
The control unit cannot be installed into the rack	Old rack system	Use a rack mount adapter according to DIN 41 494 (→  13)

7.4 Operating and Calibration

Problems



Problem	Possible cause	correction
No display appears when the unit is switched on	Unit switched off for too short a period of time	After switching the unit off, wait approx. 10 seconds before restarting
Pressure display unstable	Filter time constant too low	Increase the filtering (→ 42)
Switching functions (relays) flutter	Hysteresis too small	Modify the threshold values (→ 38)
		Increase the filtering (→ 42)
Pirani pressure reading too high	Pirani gauge contaminated	Calibrate the measuring circuit
		Clean the gauge (→ 2, [3], [4])
		Replace the gauge
Pirani measurement circuit cannot be calibrated	Combination measurement plug-in board / gauge cable / gauge is not compatible	Select correct combination (→ 1)
	Pirani gauge severely contaminated	Clean the gauge (→ 2, [3], [4])
		Replace the gauge
Cold cathode pressure reading too high	Contaminated or moist connector insulation	Clean or replace connector (→ 5, [6], [7])
	Humidity (⇒ leak current)	Keep humidity low, keep the unit switched on
Cold cathode pressure reading too low	Cold cathode gauge contaminated	Clean the gauge (→ 5, [6], [7])
«No P» is displayed	No plug-in board has been installed	Install the appropriate plug-in board ¹⁾
Incomprehensible reading	Plug-in board not screwed down	Tighten the screws
	Contacts contaminated / bent	Clean / carefully straighten contacts ¹⁾

Problem	Possible cause	Correction
Unit cannot be locked	Code 99 19 activated	<ol style="list-style-type: none"> 1. Pull the measurement plug-in boards approx. 1 cm out of the slots A and B 2. Change the code in »set up« mode 3. Reinstall the measurement plug-in boards ¹⁾
Code forgotten	—	<ol style="list-style-type: none"> 1. Pull the measurement plug-in boards approx. 1 cm out of the slots A and B ¹⁾ 2. Select the code in »set up« mode 3. Read out the code 4. Reinstall the measurement plug-in boards ¹⁾



¹⁾ Please read the instructions on  20 and in  [1] before performing any manipulations on the plug-in boards.

8 RS232C Interface

The serial interface allows communication between the TPG 300 and a computer. A terminal can also be connected for test purposes.

For RS232C communication the installation of an interface and relay plug-in board IF 300A or IF 300B is required (→  9 und  [1]).

8.1 Installation

→  20 and  [1]

8.2 Data Transmission

Information is exchanged bi-directionally, i.e. the data and control commands can flow in either direction.

8.2.1 Definitions

The following abbreviations and symbols are used:

Symbol	Meaning		
HOST	Computer or Terminal		
[...]	Non mandatory elements		
ASCII	American Standard Code for Information Interchange		
		Dec	Hex
<ETX>	END OF TEXT (CTRL C) Reset of interface	3	03
<CR>	CARRIAGE RETURN	13	0D
<LF>	LINE FEED	10	0A
<ENQ>	ENQUIRY	5	05
<ACK>	ACKNOWLEDGE	6	06
<NAK>	NEGATIVE ACKNOWLEDGE	21	15

"Send": Transfer from HOST to TPG 300

"Receive": Transfer from TPG 300 to HOST

8.2.2 Flow Control

After each ASCII string the HOST must wait for a confirmation (<ACK> or <NAK> <CR> <LF>) to ensure that the input buffer is empty.

The input buffer of the HOST must have a capacity of at least 32 bytes.

8.2.3 Communication Protocol

Send Format

Messages are transmitted to the TPG 300 as ASCII strings in the form of mnemonics and parameters. All mnemonics comprise three ASCII characters.

Spaces are ignored. <ETX> (CTRL C) clears the input buffer in the TPG 300.

The input is terminated by <CR> or <LF> or <CR><LF> ("end of message"), and evaluation in the TPG 300 is subsequently started.

The tables in section 8.3 are applicable to the mnemonics and parameters. The maximum number of digits, the data format and admissible value ranges are also specified there.

Send Protocol

HOST	TPG 300	Explanation
Mnemonics [and Parameters] —> <CR>[<LF>] —————>		Receives message with "end of message"
<————— <ACK><CR><LF>		Positive acknowledgment of a received message

Receive Format

When required with a mnemonic, the TPG 300 transmits the measurement data or parameters as an ASCII strings to the HOST.

<ENQ> must be sent to request the transmission of an ASCII string. Additional strings, according to the last selected mnemonic, are read out by repetitive transmission of <ENQ>.

If <ENQ> is received without a valid request, the ERROR word is transmitted.

Receive Protocol	HOST	TPG 300	Explanation
	Mnemonics [and Parameters] —> <CR>[<LF>]	—————>	Receives message with "end of message"
	<————— <ACK><CR><LF>		Positive acknowledgment of a received message
	<ENQ> —————>		Request to send data
	<—Measured values or parameters <————— <CR><LF>		Transmits data with "end of message "
	:		:
	<ENQ> —————>		Request to send data
	<—Measured values or parameters <————— <CR><LF>		Transmits data with "end of message"

Error Processing

The received strings are validated in the TPG 300. If an error is detected, a negative acknowledgment <NAK> is output. A corresponding flag is set in the ERROR word. Errors can be decoded after the ERROR word has been read.

Error Recognition Protocol	HOST	TPG 300	Explanation
	Mnemonics [and Parameters] —> <CR>[<LF>]	—————>	Receives message with "end of message"
	***** Transmission or programming error *****		
	<————— <NAK><CR><LF>		Negative acknowledgment of a received message
	Mnemonics [and Parameters] —> <CR>[<LF>]	—————>	Receives message with "end of message"
	<————— <ACK><CR><LF>		Positive acknowledgment of a received message

8.3 Mnemonics

SEN	Sensor On/Off	Measuring channel on/off
PA1	Pressure sensor A1	Pressure measuring channel A1
PA2	Pressure sensor A2	Pressure measuring channel A2
PB1	Pressure sensor B1	Pressure measuring channel B1
PB2	Pressure sensor B2	Pressure measuring channel B2
PUC	PE underrange control	PE underrange control
SP1	Set point 1	Switching function 1
SP2	Set point 2	Switching function 2
SP3	Set point 3	Switching function 3
SP4	Set point 4	Switching function 4
SPA	Set point A	Switching function A
SPB	Set point B	Switching function B
SPS	Set point status	Switching function status
UNI	Unit of measurement	Unit (pressure)
FIL	Filter time constant	Filter time constant
BAU	Baudrate	Baudrate
SAV	Save parameters	Store set of parameters
COD	Code lock	Operation disabling (Code)
PNR	Program number	Program version (firmware version)
TID	TPG Identification	TPG Identification (plug-in boards)
ERR	Error status	Error status



"Send (S)" and "Receive (R)" are referenced to the HOST.

8.3.1 Measurement Values

Switching Measuring Circuits On/Off

S: **SEN** [x,x,x,x] <CR><LF> Sensor on/off

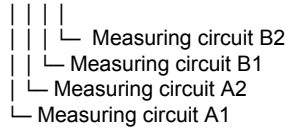

x = 0 → No measuring channel
 1 → Off
 2 → Automatic
 3 → On

R: <ACK><CR><LF>

S: <ENQ>

R: x,x,x,x <CR><LF>

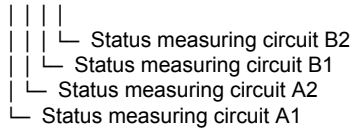

Pressure Measurement Value

S: **Pxx** <CR><LF> Pressure sensor

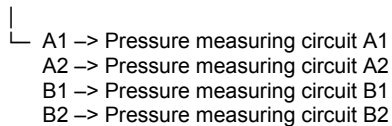

R: <ACK><CR><LF>

S: <ENQ>

R: x,x,xExxx <CR><LF> ¹⁾

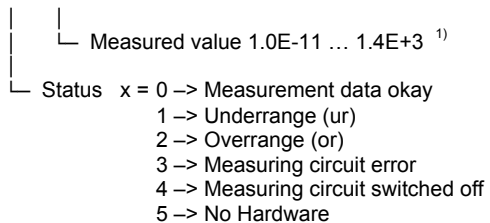

¹⁾ Depending on the actual value, the exponent (xx, succeeding sign s) can have one or two digits.

PE Underrange Control

S: **PUC** [,x] <CR>[<LF>] PE underrange control
 └─ Control x = 0 → off
 1 → on

R: <ACK><CR>

S: <ENQ>

R: x <CR><LF>
 └─ PE underrange control

8.3.2 Switching Functions

Threshold Setting, Assignment

S: **SPx** [,x,xEsxx,x,xEsxx,x] <CR>[<LF>] Set point ¹⁾
 └─ Switching function assignment
 x = 0 → No assignment
 1 → Measuring circuit A1
 2 → Measuring circuit A2
 3 → Measuring circuit B1
 4 → Measuring circuit B1
 5 → Measuring circuit A1 ²⁾
 6 → Measuring circuit A2 ²⁾
 7 → Measuring circuit B1 ²⁾
 8 → Measuring circuit B1 ²⁾

└─ Upper threshold
 9.9E+3 ... 1.0E-11 ¹⁾

└─ Lower threshold 9.9E+3 ... 1.0E-11 ¹⁾

└─ 1 → Switching function 1
 2 → Switching function 2
 3 → Switching function 3
 4 → Switching function 4
 A → Switching function A
 B → Switching function B

¹⁾ Depending on the actual value, the exponent (xx, succeeding sign s) can have one or two digits

²⁾ For self-monitoring with start-up delay

R: <ACK><CR>

S: <ENQ>

R: x.xEsxx,x.xEsxx,x <CR><LF>

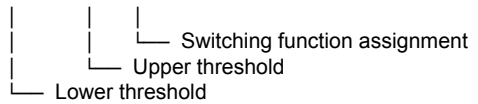

Switching Function Status

S: **SPS** <CR>[<LF>] Set point status

R: <ACK><CR>

S: <ENQ>

R: x,x,x,x,x,x <CR><LF>

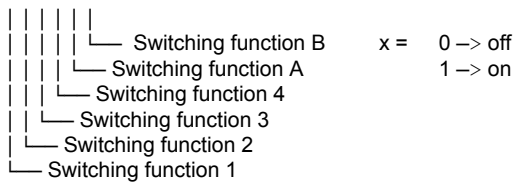

8.3.3 Display

Unit of Measurement, Pressure

S: **UNI** [,x] <CR>[<LF>] Unit of measurement

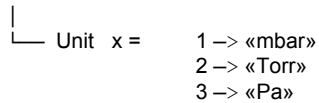

R: <ACK><CR>

S: <ENQ>

R: x <CR><LF>



8.3.4 Filter Time Constant

S: **FIL** [,x,x,x,x] <CR> [<LF>] Filter time constant

- | | | |
- | | | | └─ Measuring circuit B2 x = 1 → fast
- | | | | └─ Measuring circuit B1 2 → medium
- | | | | └─ Measuring circuit A2 3 → slow
- | | | | └─ Measuring circuit A1

R: <ACK><CR>
 S: <ENQ>

R: x,x,x,x <CR><LF>

- | | | |
- | | | | └─ Filter measuring circuit B2
- | | | | └─ Filter measuring circuit B1
- | | | | └─ Filter measuring circuit A2
- | | | | └─ Filter measuring circuit A1

8.3.5 Baud Rate

S: **BAU** [,x] <CR> [<LF>] Baud rate

- |
- └─ Baud rate x = 3 → 300 Baud
- 1 → 1200 Baud
- 2 → 2400 Baud
- 4 → 4800 Baud
- 9 → 9600 Baud

R: <ACK><CR><LF>
 S: <ENQ>

R: x <CR><LF>

- |
- └─ Baud rate

8.3.6 Storing Parameters

S: **SAV** [,x] <CR> [<LF>] Save parameters

- |
- └─ Set of Parameters
- x = 0 → Default parameters
- 1 → User parameters
- 2 → User parameters with immediate start-up (user hot start)

R: <ACK><CR><LF>
 S: <ENQ>

R: x <CR><LF>

- |
- └─ Set of parameters

8.3.8 Error Messages

Error Status

S: **ERR** <CR>[<LF>] Error status

R: <ACK><CR>

S: <ENQ>

R: xxxx <CR><LF>

└─ x = 0000 → No error
 1000 → TPG error (displayed)
 0100 → NO HWR hardware not installed
 0010 → PAR invalid Parameter
 0001 → SYN syntax error



The ERROR word is erased as it is read out. It is automatically reset if the error persists.

8.3.9 Example



"Send (S)" and "Receive (R)" are referenced to the HOST.

S: TID <CR> [<LF>]	Request for TPG identification
R: <ACK> <CR> <LF>	Positive acknowledgment
S: <ENQ>	Inquiry
R: PI 300, PE 300, IF 300 <CR> <LF>	Plug-in board types
S: SEN <CR> [<LF>]	Request for sensor status
R: <ACK> <CR> <LF>	Positive acknowledgment
S: <ENQ>	Inquiry
R: 3, 3, 1, 0 <CR> <LF>	Sensor status
S: SPB <CR> [<LF>]	Request for parameter of switching function B
R: <ACK> <CR> <LF>	Positive acknowledgment
S: <ENQ>	Inquiry
R: 1.0E-11, 9.0E-11, 0 <CR> <LF>	Threshold values and assignment
S: SPB, 6.8E-3, 9.8E-3, 2 <CR> [<LF>]	Modify threshold values of switching function B
R: <ACK> <CR> <LF>	Positive acknowledgment

S: FOL, 3, 2, 2, 2 <CR> [<LF>]	Modify filter value (syntax error)
R: <NAK> <CR> <LF>	Negative acknowledgment
S: ERR <CR> [<LF>]	ERROR query
R: 0001 <CR> <LF>	ERROR message
S: FIL, 3, 2, 2, 2 <CR> [<LF>]	Modify filter value
R: <ACK> <CR> <LF>	Positive acknowledgment
S: <ENQ>	Inquiry
R: 3, 2, 2, 2 <CR> <LF>	Filter levels
S: SEN <CR> [<LF>]	Request check of sensor status
R: <ACK> <CR> <LF>	Positive acknowledgment
S: <ENQ>	Inquiry
R: 3, 3, 2, 0 <CR> <LF>	Sensor status report
S: SAV, 1 <CR> [<LF>]	Store modified set of parameters
R: <ACK> <CR> <LF>	Positive acknowledgment
S: PA2 <CR> [<LF>]	Pressure measurement
R: <ACK> <CR> <LF>	measuring circuit A2
S: <ENQ>	Positive acknowledgment
R: 0, 8.3E-3 <CR> <LF>	Inquiry
S: <ENQ>	Status and pressure measurement
R: 1, 8.0E-4 <CR> <LF>	Inquiry
S: PB1 <CR> [<LF>]	Status and pressure measurement
R: <ACK> <CR> <LF>	Pressure measurement
S: <ENQ>	measuring circuit B1
R: 0, 1.3E-4 <CR> <LF>	Positive acknowledgment
	Inquiry
	Status and pressure measurement

To assist program development, you will find two examples of BASIC programs in the appendix (→  75).

9 Profibus Interface

The TPG 300 is able to communicate in a Profibus-DP network if the interface and relay board IF 300P is installed in slot C of the TPG 300. The IF 300P features an interface according to Profibus-DP standards and five relay contacts (switching functions and error status).

The complexity of the Profibus-DP communication protocol is beyond the scope of this document and is therefore described separately (→  [1], [8]).

10 Accessories

Type	Accessory	Ordering number
PI 300D	Pirani measurement board	PT546920-T
PI 300DN	Pirani measurement board	PT549214-T
PE 900DC9	Cold cathode measurement board	PT441375-T
CP 300C9	Pirani / cold cathode measurement board	PT441000-T
CP 300C10	Pirani / cold cathode measurement board	PT441114-T
CP 300C11	Pirani / cold cathode measurement board	PT441080-T
IF 300A	Interface and relay board (RS232C)	PT441130-T
IF 300B	Interface and relay board (RS232C)	PT441250-T
IF 300C	Interface and relay board (RS422)	PT441390-T
IF 300P	Interface and relay board (Profibus)	PT441395-T
	Mating connector for IF 300A	PT441128-T
	Mating connector for IF 300A / IF 300C	PT441129-T
	Relay connector for IF 300B	PT546999-T
	Interface cable 0.4 m for IF 300B	PT548932-T
	Mating connector for IF 300C (RS422)	PT441145-T
	Mains cable, 2.5 m, plug Schuko	P4564039YU
	Mains cable, 2.5 m, plug US	P4564039YX
	Mains cable, 2.5 m, plug UK	P4564039Y1
	Mains cable, 2.5 m, plug CH	P4564039YR
	Blanking panel for measurement boards	PT441259
	Blanking panel for interface and relay boards	PT441017
	Adapter kit for desk-top operation of the TPG 300	PT549225-T

11 Storage



Caution



Caution: electronic component
 Inappropriate storage (static electricity, humidity etc.) can damage electronic components.
 Store product in antistatic bag or container.
 Observe the corresponding specifications in the Technical Data (→  10).

12 Disposal



WARNING



Caution: substances detrimental to the environment
 Products or parts thereof (mechanical and electric components, operating fluids etc.) can be detrimental to the environment.
 Dispose of such substances in accordance with the relevant local regulations.

Separating the components

After disassembling the product, separate its components according to the following criteria:

Contaminated components

Contaminated components (radioactive, toxic, caustic or biological hazard etc.) must be decontaminated in accordance with the relevant national regulations, separated according to their materials, and disposed of.

Other components

Such components must be separated according to their materials and recycled.

Appendix

A: Conversion Tables

Mass

	kg	lb	slug	oz	cwt	sh cwt
kg	1	2.205	68.522×10^{-3}	35.274	19.684×10^{-3}	22.046×10^{-3}
lb	0.454	1	31.081×10^{-3}	16	8.929×10^{-3}	10×10^{-3}
slug	14.594	32.174	1	514.785	0.287	0.322
oz	28.349×10^{-3}	62.5×10^{-3}	1.943×10^{-3}	1	0.588×10^{-3}	0.625×10^{-3}
cwt	50.802	112	3.481	1.792×10^3	1	1.12
sh cwt	45.359	100	3.108	$1.6 \cdot 10^3$	0.893	1

Pressure

	N/m ² , Pa	bar	mbar	Torr	at	lbf/in ² , psi
N/m ² , Pa	1	10×10^{-6}	10×10^{-3}	7.5×10^{-3}	9.869×10^{-6}	0.145×10^{-3}
bar	100×10^3	1	10^3	750.062	0.987	14.504
mbar	100	10^{-3}	1	750.062×10^{-3}	0.987×10^{-3}	14.504×10^{-3}
Torr	133.322	1.333×10^{-3}	1.333	1	1.316×10^{-3}	19.337×10^{-3}
at	101.325×10^3	1.013	1.013×10^3	760	1	14.696
lbf/in ² , psi	6.895×10^3	68.948×10^{-3}	68.948	51.715	68.046×10^{-3}	1

Pressure Units used in the Vacuum Industry

	mbar	Pascal	Torr	mmWs	psi	inch of merc.
mbar	1	100	750.062×10^{-3}	10.2	14.504×10^{-3}	2.95×10^{-2}
Pascal	10×10^{-3}	1	7.5×10^{-3}	0.102	0.145×10^{-3}	2.95×10^{-4}
Torr	1.333	133.332	1	13.595	19.337×10^{-3}	3.937×10^{-2}
mmWs	9.81×10^{-2}	9.81	7.356×10^{-2}	1	1.422×10^{-3}	2.896×10^{-3}
psi	68.948	6.895×10^3	51.715	703	1	2.036
inch of merc.	33.86	3.386×10^3	25.4	345	0.491	1

Dimension

	mm	m	inch	ft
mm	1	10^{-3}	39.37×10^{-3}	3.281×10^{-3}
m	10^3	1	39.37	3.281
inch	25.4	25.4×10^{-3}	1	8.333×10^{-2}
ft	304.8	0.305	12	1

Temperature

	Kelvin	Celsius	Rankine	Fahrenheit
Kelvin	1	$^{\circ}\text{C} + 273.15$	$^{\circ}\text{R} \times 5/9$	$(^{\circ}\text{F} + 459.67) \times 5/9$
Celsius	K - 273.15	1	$(^{\circ}\text{R} - 491.69) \times 5/9$	$5/9 \times ^{\circ}\text{F} - 17.778$
Rankine	K $\times 9/5$	$(^{\circ}\text{C} \times 9/5) + 491.69$	1	$^{\circ}\text{F} + 459.67$
Fahrenheit	$9/5 \times \text{K} - 459.67$	$9/5 \times (^{\circ}\text{C} + 17.778)$	$^{\circ}\text{R} - 459.67$	1

B: Default Parameters Loading the default parameter set will activate the following values (→  45):

Parameter		Default	User
Lower threshold	Switching function 1	1.0×10^{-11} mbar	
	Switching function 2	1.0×10^{-11} mbar	
	Switching function 3	1.0×10^{-11} mbar	
	Switching function 4	1.0×10^{-11} mbar	
	Switching function A	6.0×10^{-3} mbar	
	Switching function B	6.0×10^{-3} mbar	
Upper threshold	Switching function 1	9.0×10^{-11} mbar	
	Switching function 2	9.0×10^{-11} mbar	
	Switching function 3	9.0×10^{-11} mbar	
	Switching function 4	9.0×10^{-11} mbar	
	Switching function A	8.0×10^{-3} mbar	
	Switching function B	8.0×10^{-3} mbar	
Measuring circuit assignment	Switching function 1	– (none)	
	Switching function 2	– (none)	
	Switching function 3	– (none)	
	Switching function 4	– (none)	
	Switching function A	– (none)	*)
	Switching function B	– (none)	*)
PE Measurement Underrange Control		0 (off)	
Pressure unit		mbar	
Filter time constant	Measuring circuit A1	2 (normal)	
	Measuring circuit A2	2 (normal)	
	Measuring circuit B1	2 (normal)	
	Measuring circuit B2	2 (normal)	
Baud rate		9 (9600)	
Hot start	Measuring circuit A1	– (no)	
	Measuring circuit A2	– (no)	
	Measuring circuit B1	– (no)	
	Measuring circuit B2	– (no)	
Code		00 0 (unlocked)	



*) Factory configuration in units equipped for measurement of medium and high vacuum (→  20).

C: Program Examples

To assist program development, two examples of BASIC program examples are listed below. They will run on an IBM compatible PC under BASICA:

```

20 OPEN "COM1:9600,N,8,,CS,DS,CD" AS #1
21 REM Eroeffnet COM1: mit 9600 bps,keine Paritaet und acht Daten-Bits.
22 REM CTS,DSR und CD werden nicht geprueft.
23 REM
30 ACK$ = CHR$(6): ENQ$ = CHR$(5): LF$ = CHR$(10)
100 LINE INPUT "Mnemonics? ";m$
101 REM Lesen der Nachrichten von der Tastatur, die Kommas(,)
102 REM oder andere Trennzeichen enthalten koennen.
103 IF m$ = "END" THEN GOTO 300
110 PRINT #1,m$
111 REM Sendet die Nachricht zum TPG300.
120 LINE INPUT #1,a$
121 REM Wartet auf die Quittierung der Nachricht.
130 IF INSTR(a$,ACK$) THEN PRINT "      Acknowledge"; ELSE GOTO 200
131 REM Bei positiver Quittung.
140 PRINT #1,ENQ$
141 REM Aufforderung zur Dateneubertragung.
150 LINE INPUT #1,mp$
151 REM Lesen der Messwerte oder Parameter vom TPG300.
160 PRINT "      "+RIGHT$(mp$, (LEN(mp$)-INSTR(mp$,LF$)))
161 REM Anzeige der Messwerte oder Parameter.
190 GOTO 100
200 PRINT "      Negative Acknowledge";
201 REM Bei negativer Quittung.
210 PRINT #1,ENQ$
211 REM Aufforderung zur Uebertragung des Error-Wortes.
220 INPUT #1,e
221 REM Lesen des Error-Wortes vom TPG300.
230 IF e >999 THEN PRINT "      FATAL ERROR"; : E = E-1000
240 IF e >99 THEN PRINT "      NO HARDWARE"; : E = E-100
250 IF e >9 THEN PRINT "      PARAMETER ERROR"; : E = E-100
260 IF e THEN PRINT "      SYNTAX ERROR";
270 PRINT
280 GOTO 100
300 END

```

```

20 OPEN "COM1:9600,N,8,,CS,DS,CD" FOR RANDOM AS #1
21 REM Eroeffnet COM1: mit 9600 bps,keine Paritaet und acht Daten-Bits.
22 REM CTS,DSR und CD werden nicht geprueft.
23 REM
30 CLS
40 ACK$ = CHR$(6): ENQ$ = CHR$(5): LF$ = CHR$(10)
100 LOCATE 1, 47
101 PRINT " TPG 300      "; TIMES; " soro"
102 LOCATE 10, 1
110 P$ = "PA1"
120 FOR I = 1 TO 4
121 IF I = 2 THEN P$ = "PA2"
122 IF I = 3 THEN P$ = "PB1"
123 IF I = 4 THEN P$ = "PB2"
130 PRINT #1, P$: REM Abfrage der Druck Messsstelle.
140 GOSUB 1000: REM Kommunikationsprotokoll
150 PRINT #1, ENQ$; : REM Aufforderung zur Dateneubertragung.
160 INPUT #1, s, m: REM Lesen des Messwertes.
170 IF s THEN PRINT "      "; : GOTO 200: REM Status >0
180 PRINT USING "      \ \##.#^^^"; P$; m; : REM Messdaten o.k.
200 NEXT I

```

```

300 LOCATE 5, 22
310 PRINT #1, "SPS": REM Abfrage des Waechterstatus.
320 GOSUB 1000: REM Kommunikationsprotokoll
330 PRINT #1, ENQ$: : REM Aufforderung zur Datuebertragung.
340 INPUT #1, r1, r2, r3, r4, ra, rb: REM Lesen des Status.
350 PRINT USING "R1># R2># R3># R4># RA># RB>#"; r1; r2; r3; r4; ra; rb;
999 GOTO 100
1000 REM *** Kommunikationsprotokoll ***
1010 LINE INPUT #1, a$: REM Wartet auf die Quittierung der Nachricht.
1020 IF INSTR(a$, ACK$) THEN FOR J = 1 TO 200: NEXT J: RETURN:REM Zeit >2ms (LF)
1021 REM Bei negativer Quittung.
1030 PRINT #1, ENQ$: REM Aufforderung zur Uebertragung des Error-Wortes.
1040 INPUT #1, e: REM Lesen des Error-Wortes vom TPG300.
1050 IF e > 999 THEN PRINT "          FATAL ERROR"; : e = e - 1000
1060 IF e > 99 THEN PRINT "          NO HARDWARE"; : e = e - 100
1070 IF e > 9 THEN PRINT "          PARAMETER ERROR"; : e = e - 10
1080 IF e THEN PRINT "          SYNTAX ERROR";
1090 PRINT
2000 END

```

D: Literature

-  [1] www.pfeiffer-vacuum.de
 Operating Instructions
 Plug-In Boards for Total Pressure Gauge
 Controller TPG 300
 BG 805 972 BE
 Pfeiffer Vacuum GmbH, D-35614 Asslar,
 Deutschland

-  [2] www.pfeiffer-vacuum.de
 Operating Instructions
 Pirani Gauge TPR 010
 BG 805 976 BN
 Pfeiffer Vacuum GmbH, D-35614 Asslar,
 Deutschland

-  [3] www.pfeiffer-vacuum.de
 Operating Instructions
 Pirani Gauge TPR 017
 BG 805 977 BE
 Pfeiffer Vacuum GmbH, D-35614 Asslar,
 Deutschland

-  [4] www.pfeiffer-vacuum.de
 Operating Instructions
 Pirani Gauge TPR 018
 BG 805 978 BE
 Pfeiffer Vacuum GmbH, D-35614 Asslar,
 Deutschland

-  [5] www.pfeiffer-vacuum.de
 Operating Instructions
 Cold Cathode Gauge IKR 050
 BG 805 031 BE
 Pfeiffer Vacuum GmbH, D–35614 Asslar,
 Deutschland
-  [6] www.pfeiffer-vacuum.de
 Operating Instructions
 Cold Cathode Gauge IKR 060
 BG 805 032 BE
 Pfeiffer Vacuum GmbH, D–35614 Asslar,
 Deutschland
-  [7] www.pfeiffer-vacuum.de
 Operating Instructions
 Cold Cathode Gauge IKR 070
 BG 805 033 BE
 Pfeiffer Vacuum GmbH, D–35614 Asslar,
 Deutschland
-  [8] www.pfeiffer-vacuum.de
 Communication Protocol
 Profibus-DP Interface and Relay Board for
 Total Pressure Gauge Controller TPG 300
 BG 803 980 BE
 Pfeiffer Vacuum GmbH, D–35614 Asslar,
 Deutschland

E: Index

- A -		Group	
Accessories	72	Filter	42
Automatic control	29; 30	Interface	45
- B -		Measurement unit	42
Basic Unit	8	Parameter storage	46
- C -		PE Measurement underrange ctrl	41
Code	47; 59; 68	Switching Functions	38
Assignment	47	Test programs	51
Entry	26	- H -	
Connection		Hot start	46
Factory configuration	20	- I -	
Mains power	19	Immediate start-up	46
Plug-in boards	21	Installation	13
Contents	3	Mains power connection	19
Conversion table	74	Intended use	2
- D -		Interface	60; 71
Default Parameter values	75	Baud rate	45
Disposal of product	73	Data transmission	60
- E -		Interface and Relay Plug-In Boards	9
Error messages	56	- L -	
- F -		Liability	6
Firmware Version	2; 52	Literature	78
Function		Locking code	47
Baud rate	45	- M -	
Filter assignment	43	Maintenance	
Filter time constant	44	Cleaning the unit	55
Overview	36	Measurement Plug-In Boards	8
Parameter set	46	Measurement range	11
Storage	49	Measuring	
Test program selection	51	Accuracy of measurement	24
- G -		Alignment	24
Gas type dependence	24	Gas type dependence	24
Gauge		Validity of Displayed Data	24
Switching off	30		
Gauges	8		

Measuring circuit		- R -	
Monitoring	30; 46	RS232C interface see	
switchover	29	Interface	60
 		- S -	
Mode		Safety	5; 6
see Operating mode	25	Slots	10
- N -		Status messages	22
Note symbol	7	Storing product	73
- O -		Switching functions	32
Operating mode		Switching unit off	23
»sensor«	26	Switching unit on	23
»set point«	32	Symbols used	5; 7
»set up«	35	System Overview	8
changing the	25	- T -	
Operation	22	Technical Data	
Overview		Dimensions	12
Default Parameters	75	Interface and Relay	
Operating Modes	25	Boards	11
System	8	Mains Power	
- P -		Connection	10
Parameters		Measured Values	11
Default	46; 75	Measurement Boards	11
Storage	46	Temperature	10
Plug-in boards		Thresholds	32
Identification	30	Troubleshooting	
Installing/removing	20	Error messages	56
Product identification	2	Installation Problems	57
Profibus interface	71	Operating and	
Program examples	77	Calibration Problems	58
Program Version	2; 52		

Declaration of Conformity



We, Pfeiffer Vacuum hereby declare that the equipment mentioned below complies with the provisions of the Directive relating to electrical equipment designed for use within certain voltage limits 73/23/EEC and the Directive relating to electromagnetic compatibility 89/336/EEC.

Product **Total Pressure Gauge Controller
TPG 300**

Part number **PT-546900-T**

Standards **Harmonized and international/national standards and specifications:**

- EN 61010-1 (Safety requirements for electrical equipment for measurement, control and laboratory use)
- EN 61000-6-2 (Electromagnetic compatibility: generic immunity standard)
- EN 61000-6-3 (Electromagnetic compatibility: generic emission standard)

Signature **Pfeiffer Vacuum GmbH, Asslar
16 May 2003**



**Wolfgang Dondorf
Managing director**

Notizen

Notizen

Notizen

PFEIFFER  **VACUUM**

Berliner Strasse 43

D-35614 Asslar

Deutschland

Tel +49 (0) 6441 802-0

Fax +49 (0) 6441 802-202

info@pfeiffer-vacuum.de

www.pfeiffer-vacuum.de



bg805070be